



LPB3588 Embedded Computer Datasheet V1.0



Shanghai Neardi Technology Co., Ltd.

www.neardi.com

© 2024 Shanghai Neardi Technology Co., Ltd. All rights reserved. Without written permission, no copy, photocopy, translate, or disseminate any content of this manual.

Notes: All contents only for explanatory and descriptive purposes. Please refer to the actual product. We strive to ensure consistency with the actual product. This document is provided for customers as a reference for product design and end application. It is better for you confirm the specifications and parameters carefully, provided in the document to ensure they meet the design or application requirements of the product. What's more, it is strongly recommended that customers conduct detailed tests based on our actual products in the actual application scenario to ensure they meet the final usage requirements. Neardi Technology does not assume any responsibility for any damage suffered due to the use of the document, materials, and product functions.

Due to product version upgrades or other needs, our company may update the manual. If you need the latest version of the manual, please contact our company. We always adhere to the principle of customer first and provide customers with fast and efficient support services. If you have any needs, please feel free to contact our company at any time. Contact information is as follows:

Shanghai Neardi Technology Co., Ltd.

Phone: +86 021-20952021

Website: www.neardi.com

Email: sales@neardi.com

Version History

Version	Date	Description
V1.0	2022/8/23	Initial version

Contents

1.Product Introduction	3
2.Function Overview	4
3.Technical Specifications	7
4.Appearance and Dimensions	9
5.Interface Definition	10
6.Application Scenarios	13
7.Ordering Model	14
8.About Near<i>di</i>	15

1.Product Introduction

The LPB3588 intelligent computer is a product meticulously designed based on the Rockchip RK3588 chip. The body is made of full aluminum material with a fanless design and an innovative internal structural combination, allowing key heat-generating components such as the CPU and PMU to efficiently conduct heat to the external aluminum casing, using the entire body casing as a heat dissipation material. This design not only enables the LPB3588 to perform excellently in more severe working environments but also allows it to be widely applied in various industrial scenarios.

The LPB3588 has a variety of interfaces, including 3 Type-A USB 3.0 HOSTs, and 1 full-function Type-C interface, suitable for connecting multiple USB cameras. It has 2 onboard mini-PCIe interfaces that can be expanded to connect 4G modules, 5G modules, and NPU computing cards with mini-PCIe interfaces based on RK1808. In addition, the LPB3588 supports dual-band WIFI 6, BT5.0, 2 Gigabit Ethernet, 2 CANBUS, 1 RS485, and 4 RS232 communication module interfaces. It provides 3 HDMI outputs, 1 DP output, 1 dual-channel LVDS interface and backlight control and touch screen interface, 1 HDMI input, supports audio input and output, can be connected to a 10W@8 Ω stereo sound box, has a built-in M.2 NVMe 2280 solid-state drive interface, and supports multi-screen independent display.

The LPB3588 intelligent computer supports 4-relay control, including 4 groups of normally open, normally closed, and COM ports; supports 4 switch inputs, each with optocoupler isolation, supporting active input (up to 36V) or passive input; supports 4 analog inputs, supporting 0~16V voltage detection or 4-20mA current detection, and can be connected to various sensors externally.

The LPB3588 supports multiple operating systems such as Android, buildroot, Debian, and Ubuntu, offering excellent high performance, high reliability, and high scalability. The system source code is open to users, providing open-source support for secondary development and customization. We are committed to providing developers and enterprise users with comprehensive technical services to assist users in efficiently completing research and development work and helping customers quickly bring products to market.

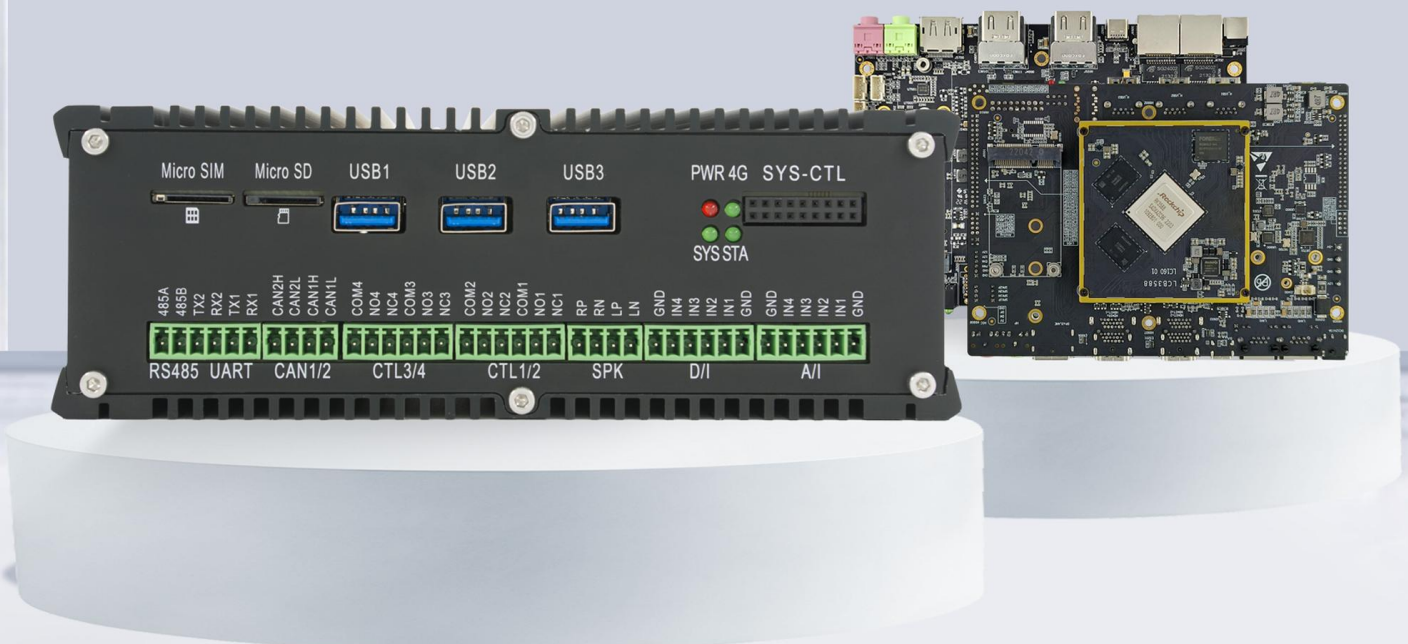

2. Function Overview



High-Performance Processor

CPU	8nm advanced process technology with an 8-core 64-bit architecture (4A76 + 4A55), offering high performance with low power consumption.
GPU	ARM Mali-G610 MC4 GPU, featuring a dedicated 2D graphics acceleration module.
NPU	6TOPS computing power for AI-related tasks.
VPU	Capable of 8K video encoding and decoding, as well as 8K display output.
DDR	LPDDR4 memory, with options for 4GB, 8GB, or 16GB capacities.
eMMC	eMMC 5.1 storage, with options for 32GB, 64GB, or 128GB capacities.



Rich Interfaces

9-36V wide voltage input

3 HDMI outputs, 1 HDMI input, 1 DP interface output, 1 Type-C with DP1.4 display interface output, 1 dual 8-bit LVDS output, supporting up to 6 screens with independent display.

2 Gigabit Ethernet ports, dual-band WIFI 6, expandable with 4G/5G modules

3 Type-A USB 3.0 HOSTs

2*Uart, 2*CAN BUS, 4*RS232, 1*RS485

4*Relays, 4*digital input, 4*analog input



Scalable NPU Computing Power

NPU computational power can be expanded up to 12 TOPS; capable of externally connecting two 3 TOPS computational power cards.

Demo programs are provided.



Operating System

Android

Linux (Buildroot / Debian / Ubuntu)

Kylin



Open Source Materials

WIKI Documentation <http://www.neardi.com/cms/en/wiki.html>

Quick Start

Firmware Upgrade

Android Development

Linux Development

Kernel Drivers

DEMO

System Customization

Accessories

[Frequently Asked Questions \(FAQ\)](#)

[Release Notes](#)

Hardware Materials

[Product 2D/3D Drawings](#)

Software Materials

[Firmware Tools and Drivers](#)

[Android Source Code and Images](#)

[U-Boot and Kernel Source Code](#)

[Debian/Ubuntu/Buildroot System Files](#)

3. Technical Specifications

Basic Parameters

SOC	RK3588 8nm; 8-core 64-bit processor architecture (4A76 + 4A55).
GPU	ARM Mali-G610 MC4; Supports OpenGL ES 1.1/2.0/3.1/3.2; Vulkan 1.1/1.2; OpenCL 1.1/1.23/2.0; High-performance 2D image acceleration module.
NPU	6TOPS computing power / 3-core architecture; Supports int4/int8/int16/FP16/BF16/TF32.
VPU	Supports H.265/H.264/AV1/VP9/AVS2 video decoding, up to 8K60FPS; Supports H.264/H.265 video encoding, up to 8K30FPS.
DDR	LPDDR4, with options for 4GB/8GB/16GB.
eMMC	eMMC 5.1, with options for 32GB/64GB/128GB.
PMU	RK806
OS	Android / Ubuntu / Buildroot / Debian

Hardware Specifications

Power	DC 9-36V
USB	3*Type-A USB3.0 HOST
	1*Type-c USB3.1 OTG
Display out	3*Type-A HDMI 2.0
	1* DP1.2
	1*Duel channel LVDS

Display in	1* HDMI-IN
Audio	1*φ3.5mm audio out, 1*φ3.5mm microphone 2*Speaker output with 10W@8Ω
Net work	2*10/100/1000Mbps Ethernet
expandable interface	1*mini PCIe for 2G/3G/4G/5G LTE module ; 1*mini PCIe for AI cards (optional) ; M.2 NGFF (M-KEY) PCIE V2.1 x4 with NVMe SSD supported ; 1*SATA3.0 ;
Connectivity	2*Uart, 2*CAN BUS, 4*RS232, 1*RS485
Input/output	4*Relays, 4*digital input, 4*analog input

Other Parameters

Dimensions	L*W*H(mm) 182*120*63
Operating Temperature	-10 ~ 70°C
Weight	Approximately 1132g (excluding peripherals)

4. Appearance and Dimensions

4.1 Appearance



4.2 Dimensions

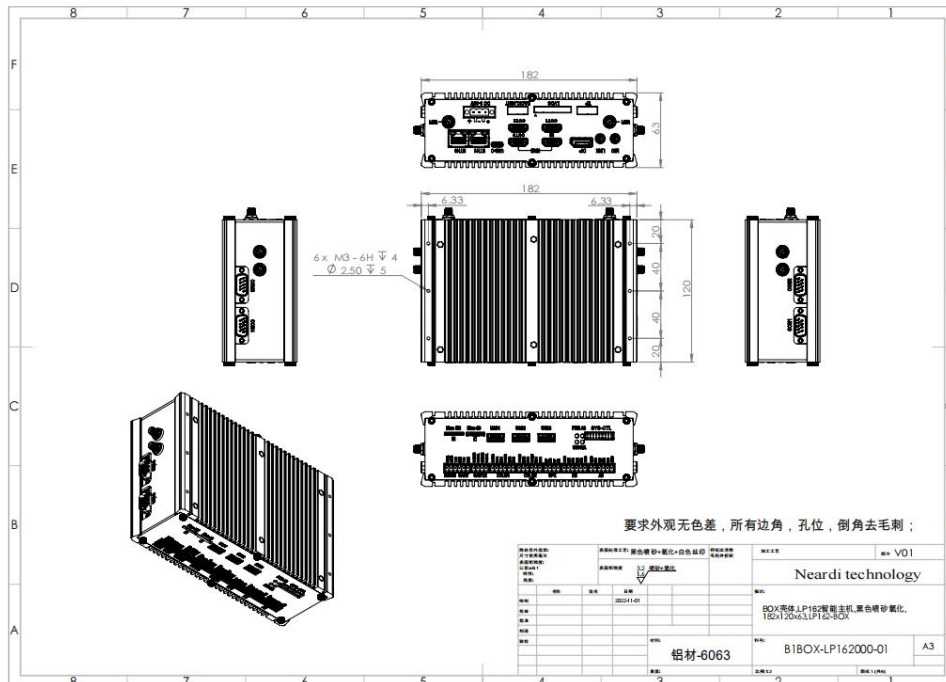

5.Interface Definition

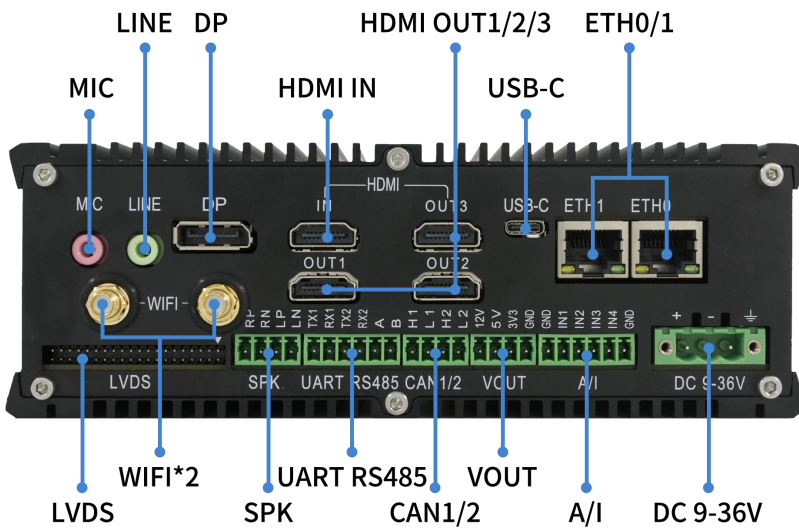
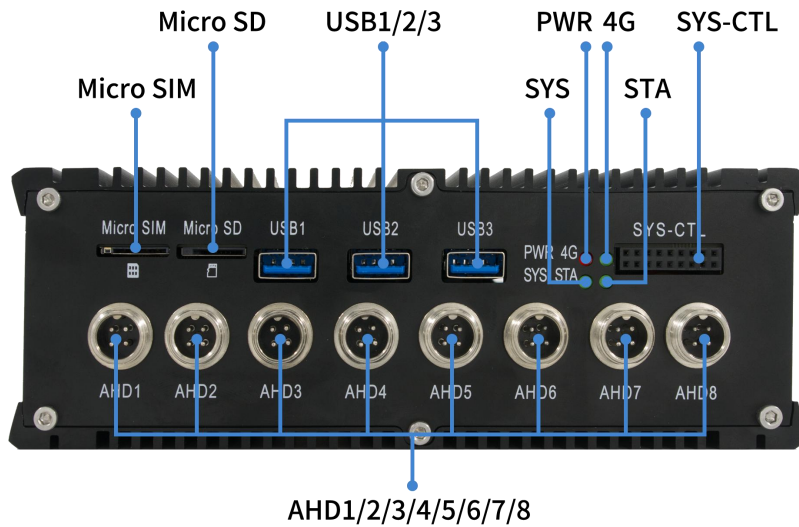

Reserved Antenna Interface*2

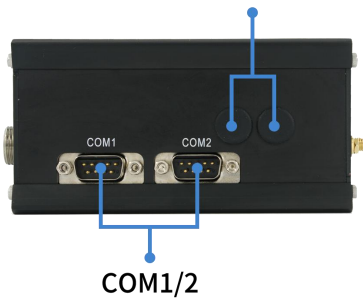

Reserved Antenna Interface*2

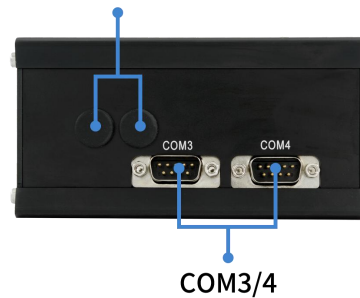

Part Name	Part Specifications	Part Notes
MIC	φ3.5mm 3-L Jack	Micphone In
LINE	φ3.5mm 3-L Jack	L/R audio out
DP	VGA output	DP Output up to 1920*1080@60HZ
HDMI IN	Type-A HDMI 2.0	HDMI 2.0 input up to 4K@30HZ(系统版本不同规格不同)
HDMI OUT1	Type-A HDMI 2.1	HDMI 2.0 output up to 4K@60HZ(系统版本不同规格不同)
HDMI OUT2	Type-A HDMI 2.1	HDMI 2.0 output up to 4K@60HZ(系统版本不同规格不同)
HDMI OUT3	Type-A HDMI 2.0	HDMI 2.0 output up to 4K@30HZ(系统版本不同规格不同)
USB-C	Type-C USB3.1 otg	Full function type-C USB3.1 with DP output
EHT 1	Gigabit Ethernet	10/100/1000-Mbps data transfer rates
ETH 0	Gigabit Ethernet	10/100/1000-Mbps data transfer rates
WIFI*2	SMA connector	2.4G/5.8G frequency
TP	PH2.0mm 6pin wafer	I2C signal with RST and EN
LVDS	PH2.0mm 2x15pin header	Dual channel 24bit LVDS output
BACKLIGHT	PH2.0mm 2x20pin header	LCD backlight control
DC 9-36V	KF2EDGRM-5.08-3P	Can used with DC-12V simultaneously
Micro-SIM	Push-Push Micro SIM Socket	For Micro SIM Card (1.8/3.3V)
Micro-SD	Push-Push TF socket	TF Card
USB1	Type-A USB3.0 host	The first USB3.0 host for external devices
USB2	Type-A USB3.0 host	The second USB3.0 host for external devices

USB3	Type-A USB3.0 host	The third USB3.0 host for external devices
PWR/SYS	Red and Green LEDs	Power status indicate
4G/STA	Green led *2	Work status and 3G/4G Module Status Indicator
SYS-CTL	System control or debug	2.54MMpitch,2*9PIN,A2541HWR-2x9P
RS485 UART	KF2EDGR-3.5-6P	RS485 signal, UART 3.3V TTL signal
CAN1/2	KF2EDGR-3.5-4P	CAN bus signal
CTL1/2	KF2EDGR-3.5-6P	Relays control
CTL3/4	KF2EDGR-3.5-6P	Relays control
SPK	KF2EDGR-3.5-4P	L/R output with 10W@8Ω
D/I	KF2EDGR-3.5-6P	Photocoupler isolation, up to 36V, active or passive
A/I	KF2EDGR-3.5-6P	0-16V voltage detect or 4-20mA current detect
COM1	DB-9 male connector	RS232 signal
COM2	DB-9 male connector	RS232 signal
COM3	DB-9 male connector	RS232 signal
COM4	DB-9 male connector	RS232 signal

6.Application Scenarios



AI



Machine Vision



Industrial Control



Energy and Power



Smart Tablet



VR



Smart Logistics



New



Smart Commercial

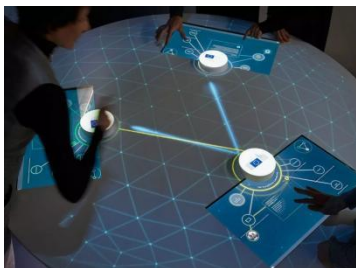

Object Recognition



Vehicle terminal



Security Surveillance

7.Ordering Model

Product Model	Status	CPU	DDR	eMMC	Operating Temperature
LP16243200	ACTIVE	RK3588	4GB	32GB	-10°C - 70°C
LP16286400	ACTIVE	RK3588	8GB	64GB	-10°C - 70°C
LP1629A800	ACTIVE	RK3588	16GB	128GB	-10°C - 70°C

*For customized non-standard orders, please contact us via email at sales@neardi.com.

8.About NearDi













Shanghai NearDi Technology Co., Ltd., established in 2014, is a national-level high-tech enterprise, a strategic partner of Rockchip, and an authorized agent for Black Sesame Technologies. We focus on the research and development and production of enterprise-level open-source hardware platforms, offering customers core modules, industry-specific boards, development boards, touch panels, and industrial control hosts. Adhering to the core philosophy of technological innovation and professional service, leveraging NearDi Technology's technical strengths and industry experience, we assist our partners in achieving rapid mass production of their products.

Company Advantages

Software Design / Custom OS / Product ODM / Bulk Delivery

Products

Rockchip

System On Module				
 LCB3588/J	 LCB3568/J	 LCB3566	 LCB3399Pro	 LCB3399
Development Board				
 LKD3588/J	 LKD3568/J	 LKD3566	 LKD3399Pro	 LKD3399
Embedded Computer				
 LPB3588	 LPM3588	 LPC3588	 LPB3568	 LPB3399Pro





Black Sesame Technologies

 SOM-A-A1000	 SOM-π-A1000	 SOM-B-A1000	 SOM-A1000 开发者套件
--	--	--	--

Vehicle Terminal

 LPA3588	 LPA3568	 LPA3399Pro	 LPS3399Pro
--	--	---	--

WIFI Module

 FD7352S	 FD7352P	 FD7352M	 FD7155U	 FD7256S
--	--	--	--	--