

neardi

LPA3399Pro Embedded Computer Datasheet V1.0



Shanghai Neardi Technology Co., Ltd.

www.neardi.com

© 2024 Shanghai Neardi Technology Co., Ltd. All rights reserved. Without written permission, no copy, photocopy, translate, or disseminate any content of this manual.

Notes: All contents only for explanatory and descriptive purposes. Please refer to the actual product. We strive to ensure consistency with the actual product. This document is provided for customers as a reference for product design and end application. It is better for you confirm the specifications and parameters carefully, provided in the document to ensure they meet the design or application requirements of the product. What's more, it is strongly recommended that customers conduct detailed tests based on our actual products in the actual application scenario to ensure they meet the final usage requirements. Neardi Technology does not assume any responsibility for any damage suffered due to the use of the document, materials, and product functions.

Due to product version upgrades or other needs, our company may update the manual. If you need the latest version of the manual, please contact our company. We always adhere to the principle of customer first and provide customers with fast and efficient support services. If you have any needs, please feel free to contact our company at any time. Contact information is as follows:

Shanghai Neardi Technology Co., Ltd.

Phone: +86 021-20952021

Website: www.neardi.com

Email: sales@neardi.com

Version History

Version	Date	Description
V1.0	2022/8/23	Initial version

Contents

- 1.Product Introduction 3**
- 2.Function Overview4**
- 3.Technical Specifications 6**
- 4.Appearance and Dimensions 8**
- 5.Interface Definition 9**
- 6.Application Scenarios 14**
- 7.Ordering Model 15**
- 8.About Neardi16**

1.Product Introduction

The LPA3399Pro intelligent computer is a portable computing host developed based on the Rockchip RK3399Pro platform, designed for scenarios that require a large amount of visual computation. It has an integrated NPU computing unit with a computational power of 3.0TOPS, supporting a variety of algorithmic models. This product is a foundational device in AI scenarios, equipped with a rich set of hardware interfaces. Users only need to port the algorithms to this platform to quickly bring the product to market.

The LPA3399Pro vision host supports input from 5 AHD cameras and can also support input from various depth cameras, making it suitable for products in machine vision and ADAS areas. AHD cameras are widely used in the automotive field, employing coaxial transmission that can reach tens of meters, using industry-standard aviation connectors for stable and reliable connections that are easy to install.

The LPA3399Pro vision host integrates dual-band WIFI 802.11a/b/g/n/ac, BT5.0 low-power Bluetooth, GPS+BD dual-mode navigation, seven-mode global 4G communication, and a 9-axis motion sensor. It supports a variety of communication interfaces, including RS232, RS485, CAN, and 1000M Ethernet. The rich interfaces allow users to develop a range of excellent products.



2. Function Overview



High-Performance Processor

CPU

Dual-core Cortex-A72 and quad-core Cortex-A53 architecture, with a clock speed up to 1.8GHz, offering high performance and low power consumption.

GPU

ARM Mali-T860MP4 GPU, supporting AFBC (Advanced Frame Buffer Compression).

NPU

3 TOPS of computational power.

VPU

Capable of 4K/1080P video encoding and decoding, with 4K display output.

DDR

LPDDR4/4x, with options for 3GB or 6GB.

eMMC

eMMC 5.1, with options for 16GB or 64GB.



Rich Interfaces

5 AHD high-definition cameras, 4 USB cameras.

Dual-band WIFI, BT5.0, 2G/3G/4G global data transmission, GPS/Beidou dual-mode positioning.

2 USB 3.0 OTG ports, 2 USB 2.0 HOST ports.

1 HDMI port.



Operating System

Android

Linux (Buildroot / Debian / Ubuntu)



Open Source Materials

WIKI Documentation <http://www.neardi.com/cms/en/wiki.html>

Quick Start

Firmware Upgrade

Android Development

Linux Development

Kernel Drivers

DEMO

System Customization

Accessories

Frequently Asked Questions (FAQ)

Release Notes

Hardware Materials

Product 2D/3D Drawings

Software Materials

Firmware Tools and Drivers

Android Source Code and Images

U-Boot and Kernel Source Code

Debian/Ubuntu/Buildroot System Files

3. Technical Specifications

Basic Parameters

SOC	RK3399Pro; a dual-core Cortex-A72 plus quad-core Cortex-A53 architectural processor.
GPU	Mali-T860MP4 GPU, supporting OpenGL ES 1.1/2.0/3.0/3.1, OpenVG 1.1, OpenCL, DirectX 11; supports AFBC (Advanced Frame Buffer Compression).
NPU	3 TOPS computational power; supports 8-bit/16-bit operations; compatible with TensorFlow and Caffe models.
VPU	Capable of 4K VP9 and 4K 10-bit H265/H264 video decoding, up to 60fps at 1080P; multi-format video decoding (WMV, MPEG-1/2/4, VP8); 1080P video encoding, supporting H.264 and VP8 formats.
DDR	LPDDR4/LPDDR4X, with options for 3GB or 6GB.
eMMC	eMMC 5.1, with options for 16GB, 32GB, 64GB, or 128GB.
PMU	RK806
OS	Android / Ubuntu / Buildroot / Debian

Hardware Specifications

Power	DC 9V - 36V
USB	2*Type-A USB3.0 HOST, 2*Type-A USB2.0 OTG
Display output	1*Type-A HDMI 2.0
Audio	ø3.5mm audio out and microphone input

Storage	Micro SD card with SDIO 3.0 protocol
Connectivity	1*Uart, 2*RS232, 1*RS485
	1*10/100/1000Mbps Ethernet
Net work	Wi-Fi 2.4GHz/5GHz,802.11a/b/g/n/ac;
	BT V5.0 with BLE supported
Camera Interface	5*AHD input up to 1920*1080@30fps per channel

Other Parameters

Dimensions	L*W*H(mm)	200*120*57.7
Operating Temperature		-10 ~ 70°C
Weight		Approximately 1212g (excluding peripherals)

4. Appearance and Dimensions

4.1 Appearance



4.2 Dimensions

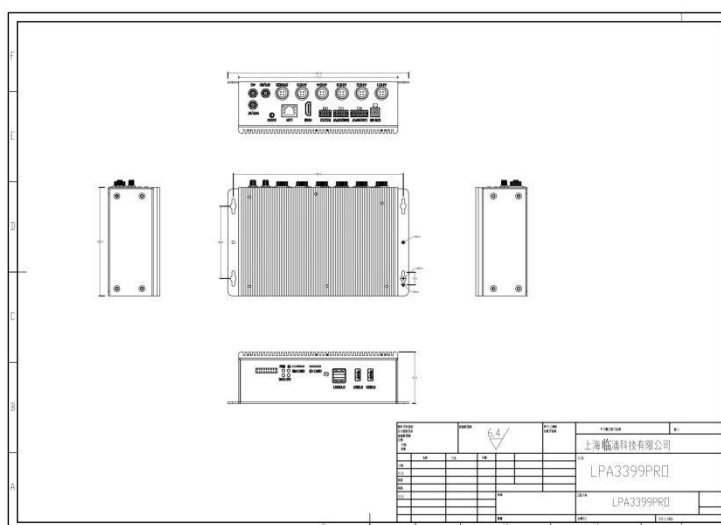

5.Interface Definition

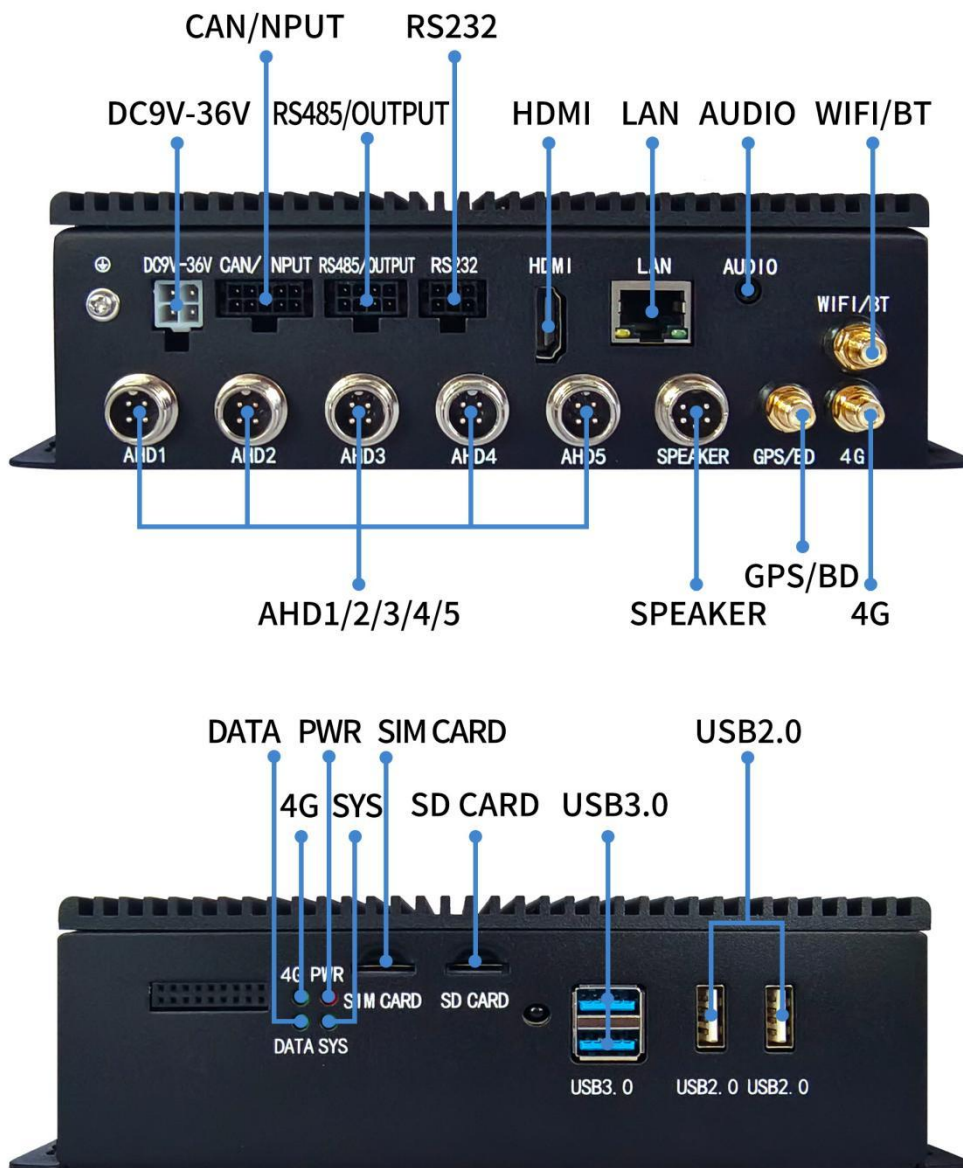

Interface Label	Interface Description
DC9V-36V	Power input and high/low level detection, supports working voltage from 9V to 36V; automotive connector, 4.2mm pitch, 4Pin curved pin dual row, Molex, 5569-04A2;

CAN/INPUT	CAN bus and detection of 6 input signals, isolated design of over 3KV, can withstand voltage $\pm 36V$; automotive connector, 3.0mm pitch, 10Pin curved pin dual row, Molex, 43045-1000;
RS485/OUTPUT	RS485 bus and 4-channel 12V voltage signal output, $\pm 15KV$ ESD protection; automotive connector, 3.0mm pitch, 8Pin curved pin dual row, Molex, 43045-0800;
RS232	Two RS232 buses, $\pm 15KV$ ESD protection; automotive connector, 3.0mm pitch, 6Pin curved pin dual row, Molex, 43045-0600;
HDMI	HDMI 2.0a supports 4K 60Hz display, supports HDCP 1.4/2.2; Type-A female socket;
LAN	Gigabyte 1000M Ethernet; RJ45 socket;
AUDIO	Left and right channel output, microphone input, national standard; $\phi 3.5mm$ headphone jack, four-position;
WIFI/BT	WIFI/Bluetooth antenna;
AHD1-AHD5	Analog high-definition video signal input, supports all formats and resolutions of AHD signals; aviation plug male, GX12-4 core;
Speaker	Dual-channel stereo output and analog microphone input, 10W/8 Ω *2CH; aviation plug male, GX12-6 core;
GPS/BD	Navigation positioning antenna, supports GPS and Beidou dual-mode positioning; SMA socket, external thread, internal hole;
LTE	4G antenna, supports global network, SMA socket, external thread,

	internal hole;
SYS-CTL	System control or debugging;
4G	4G network status indicator light;
PWR	Power indicator light;
DATA/SYS	Custom status indicator light, controlled by GPIO;
SIM card	Micro SIM card slot for Mini-PCIe 4G LTE module;
SD card	Compatible with SDIO 3.0 protocol, supports system boot;
USB3.0	USB3.0, Type-A female socket, double-layer;
USB2.0	USB2.0, Type-A female socket;

AHD1-AHD5 接口定义

Pin number	Pin name	Pin description
1	VCC12V_AHD	AHD 摄像头电源输出正极, 12V-0.5A
2	GND	AHD 摄像头 GND
3	NC	NC
4	AHD_video	AHD 摄像头视频输入

SPEAKER 接口定义

Pin number	Pin name	Pin description
1	SPK_LP	Speaker 左声道正极
2	SPK_LN	Speaker 左声道负极
3	SPK_RN	Speaker 右声道负极

4	SPK_RP	Speaker 右声道正极
5	Mic_P	模拟麦克风正极
6	Mic_N	模拟麦克风负极

CAN/INPUT 接口定义

Pin number	Pin name	Pin description
1	CAN_H	CAN 总线高电平,3KV 以上电气隔离
2	GND	输入检测信号参考地
3	GPIO_IN1	输入检测信号, 3KV 以上电气隔离, 支持 0~36V
4	GPIO_IN3	输入检测信号, 3KV 以上电气隔离, 支持 0~36V
5	GPIO_IN5	输入检测信号, 3KV 以上电气隔离, 支持 0~36V
6	CAN_L	CAN 总线低电平, 3KV 以上电气隔离
7	GND	输入检测信号参考地
8	GPIO_IN2	输入检测信号, 3KV 以上电气隔离, 支持 0~36V
9	GPIO_IN4	输入检测信号, 3KV 以上电气隔离, 支持 0~36V
10	GPIO_IN6	输入检测信号, 3KV 以上电气隔离, 支持 0~36V

RS485/OUTPUT 接口定义

Pin number	Pin name	Pin description
1	OUTPUT1	输出控制信号
2	OUTPUT3	输出控制信号
3	GND	输出控制信号参考地
4	RS485_A	RS485 总线 A 输出信号
5	OUTPUT2	输出控制信号

6	OUTPUT4	输出控制信号
7	GND	输出控制信号参考地
8	RS485_B	RS485 总线 B 输出信号

RS232 接口定义

Pin number	Pin name	Pin description
1	RS232_TX1	第一路 RS232 总线的发送
2	GND	RS232 总线参考地
3	RS232_TX2	第二路 RS232 总线的发送
4	RS232_RX1	第一路 RS232 总线的接收
5	GND	RS232 总线参考地
6	RS232_RX2	第二路 RS232 总线接收

6.Application Scenarios



AI



Machine Vision



Industrial Control



Energy and Power



Smart Tablet



VR



Smart Logistics



New



Smart Commercial

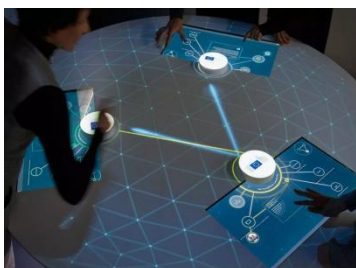

Object Recognition



Vehicle terminal



Security Surveillance

7.Ordering Model

Product Model	Status	CPU	DDR	eMMC	Operating Temperature
LP11031600	ACTIVE	RK3399Pro	3GB	16GB	-10°C - 70°C
LP11061600	ACTIVE	RK3399Pro	6GB	16GB	-10°C - 70°C
LP11066400	ACTIVE	RK3399Pro	6GB	64GB	-10°C - 70°C

*For customized non-standard orders, please contact us via email at sales@neardi.com.

8.About NearDi













Shanghai NearDi Technology Co., Ltd., established in 2014, is a national-level high-tech enterprise, a strategic partner of Rockchip, and an authorized agent for Black Sesame Technologies. We focus on the research and development and production of enterprise-level open-source hardware platforms, offering customers core modules, industry-specific boards, development boards, touch panels, and industrial control hosts. Adhering to the core philosophy of technological innovation and professional service, leveraging NearDi Technology's technical strengths and industry experience, we assist our partners in achieving rapid mass production of their products.

Company Advantages

Software Design / Custom OS / Product ODM / Bulk Delivery

Products

Rockchip

System On Module				
 LCB3588/J	 LCB3568/J	 LCB3566	 LCB3399Pro	 LCB3399
Development Board				
 LKD3588/J	 LKD3568/J	 LKD3566	 LKD3399Pro	 LKD3399
Embedded Computer				
 LPB3588	 LPM3588	 LPC3588	 LPB3568	 LPB3399Pro





Black Sesame Technologies

 SOM-A-A1000	 SOM-π-A1000	 SOM-B-A1000	 SOM-A1000 开发者套件
--	--	--	--

Vehicle Terminal

 LPA3588	 LPA3568	 LPA3399Pro	 LPS3399Pro
--	--	---	--

WIFI Module

 FD7352S	 FD7352P	 FD7352M	 FD7155U	 FD7256S
--	--	--	--	--